

Playground at 59 Horse Pond Road



Town of Sudbury ADA Transition Plan

December 2020



Institute for Human Centered Design

200 Portland Street, Boston, MA 02114
www.IHCDesign.org • info@IHCDesign.org
617-695-1225 voice/ tty

Background

The playground located at 59 Horse Pond Road is also called Crime Lab Field because it is behind the Massachusetts State Police Crime Lab. The facility includes a baseball field that is used for little league games and picnic areas. There is access to the field via Wilshire Road.

Key Accessibility Issues

Exterior Access Routes

Accessibility issues include lack of an accessible route from Wilshire Road to the baseball field, team seating areas and the spectator seating area.

Picnic Area

Accessibility issues include lack of an accessible route to the picnic area and a lack of an accessible picnic table.

Additional Accessibility Issues

- Team and spectator seating benches lack a 36" by 48" clear floor space alongside them.



The diagram above shows a proposed accessible route to the sports field, team seating areas, spectator seating area and picnic area.

Order of Magnitude Cost Estimates

- Provide an accessible route to the field from Wilshire Road: \$3,200
- Provide an accessible picnic table and an accessible route to the table: \$5,560
- Provide an accessible route to the baseball field and seating areas, as well as clear floor space alongside the team seating and spectator seating benches: \$3,136

Total: \$11,896

Best Practice and Inclusive Design



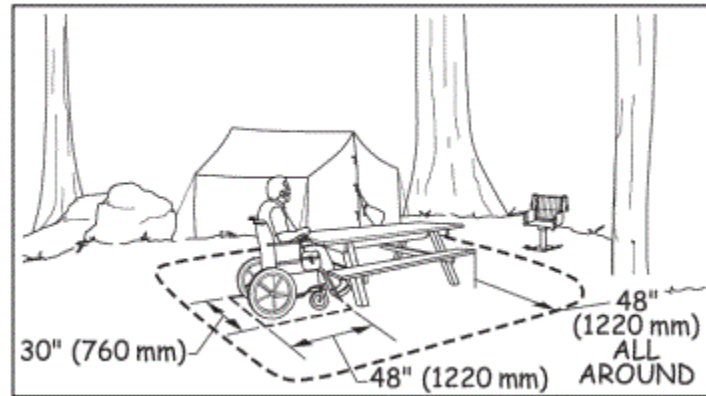

Best practice and inclusive design recommendations include elements that are not required in the standards but may create enhanced experiences for all users.

Playground at 59 Horse Pond Road



- Recommend providing a 48" wide min. stable, firm and slip resistant surface under and around an accessible picnic table once it is connected to an accessible route. See the following image:



**Town of Sudbury
Playground at 59 Horse Pond Road**

ID	Location	Floor	Room	Element	Type	Photo	Issues	Current Measure	Recommendations	Quantity	Price	Cost Estimation
Approach and Entrance												
Exterior Access Route												
1	Route from East End of Wilshire Road	Ext.		Exterior Access Route	Walkway		Exterior route < 48" wide Cross slope > 1:50 (2.00%) Running slope > 1:20 (5%) Route not maintained in operable working condition	23" 10.4% 10.1% -	Provide an accessible route to the field from Wilshire Road. (Cost estimate for a 100' long, 4' wide accessible stone dust route.)	1	3200	\$3200
Access to Goods and Services												
Picnic Tables												
2	Sunny Picnic Area	Ext.		Picnic Tables	N/A		Toe or knee clearance at table not provided Picnic table not on an accessible route	- -	Provide at least one picnic table with top between 28"- 34" above the ground and 27" clear height underneath. Ensure that the picnic table is connected to an accessible route. (Cost estimate for a 130' long, 4' wide stone dust route and an accessible picnic table.)	1	5560	\$5560
Play and Sport Areas												
Field												
3	East Team Seating Area	Ext.		Field	Baseball		Accessible spaces are not provided at team seating Not connected to an accessible-route	- -	Provide a 36" x 48" clear floor space at team seating alongside the bench. Provide an accessible route to the team seating area. (Cost estimate for a 36" by 48" stone dust clear floor space alongside the bench and a 30' long, 4' wide accessible stone dust route from the edge of the field to the team seating area.)	1	1056	\$1056
4	West Team Seating Area	Ext.		Field	Baseball		Accessible spaces are not provided at team seating Not connected to an accessible-route	- -	Provide a 36" x 48" clear floor space at team seating. Provide an accessible route to the team seating area. (Cost estimate for a 36" by 48" stone dust clear floor space alongside the bench and a 30' long, 4' wide accessible stone dust route from the spectator seating area to the west team seating area.)	1	1152	\$1152

**Town of Sudbury
Playground at Horse 59 Pond Road**

ID	Location	Floor	Room	Element	Type	Photo	Issues	Current Measure	Recommendations	Quantity	Price	Cost Estimation
5	Spectator Seating Area	Ext.		Field	Baseball		Accessible spaces not provided at sidelines seating Not connected to an accessible-route	- -	Provide a 36" x 48" clear floor space at sidelines seating. Provide an accessible route to the the spectator seating area. (Cost estimate for a 36" by 48" stone dust clear floor space alongside the bench and an 26' long, 4' wide accessible stone dust route from the east team seating area to the spectator seating area.)	1	928	\$928
Best Practice												
6	Sunny Picnic Area	Ext.						-	Recommend providing a 48" wide min. stable, firm and slip resistant surface under and around an accessible picnic table.	1	-	\$0